

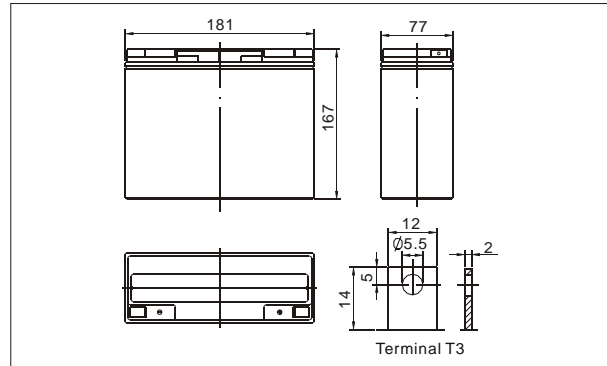

● Outer dimensions (mm)



The CHIWAY sealed lead-acid rechargeable battery (VRLA battery) is leak-proof and maintenance free. The Superiority of VRLA battery is derived from its uniquely efficient oxygen recombination technology. The oxygen evolved from the positive plates diffuses through the micro porous glass fiber mat to the negative plates where it is changed back to water by recombination reaction, eliminating the need for water addition. The result is a maintenance free battery.

● Battery Construction

Component	Positive plate	Negative plate	Container	Cover	Safety valve	Terminal	Separator	Electrolyte
Raw material	Lead dioxide	Lead	ABS	ABS	Rubber	Copper	Fiberglass	Sulfuric acid

● General Features

- Absorbent Glass Mat (AGM) technology for efficient gas recombination of up to 99% and freedom from electrolyte maintenance or water adding.
- Not restricted for air transport-complies with IATA/ICAO Special Provision A67.
- UL-recognized component.
- Can be mounted in any orientation.
- Computer designed lead, calcium tin alloy grid for high power density.
- Long service life, float or cyclic applications.
- Maintenance-free operation.
- Low self discharge.

● Application

- Electric powered vehicles
- Golf cars and buggies
- PDA equipments as laptop computer,
- Camera, phone sets, medical sets
- Power tools, Lawn mowers, vacuum cleaners
- Electric Powered Toys
- Wheel Chairs

● Specifications

Nominal Voltage		12V
Capacity (20 hr 25°C)		20Ah
Design Life		3-5 Years
Dimensions	Length	181 mm (7.13 inch)
	Width	77 mm (3.03 inch)
	Height	167 mm (6.57 inch)
	Total Height	167 mm (6.57 inch)
Approx. Weight		5.90Kg (13.01 lbs)
Capacity 25°C (77°F)	20 hr rate	20Ah
	10 hr rate	18.6Ah
	3 hr rate	17.0Ah
	1 hr rate	12.0Ah
Internal Resistance (Full charged Battery at 25°C (77°F))		15 mΩ

Capacity affected by Temperature (20hr)	40°C	102%
	25°C	100%
	0°C	85%
	-15°C	65%
Self-Discharge at 25°C	3 month	Remaining capacity: 91%
	6 month	Remaining capacity: 82%
	12 month	Remaining capacity: 65%
Normal operating temperature		25°C ± 3°C (77°F ± 5°F)
Operating temperature range		-15°C ~ 50°C (5 ~ 122°F)
Float charging voltage (25°C)		13.6 to 13.8V
Cyclic charging voltage (25°C)		14.5 to 14.9V
Maximum charging current		8.0A
Terminal material		Copper
Maximum Discharge current		300A (5sec)

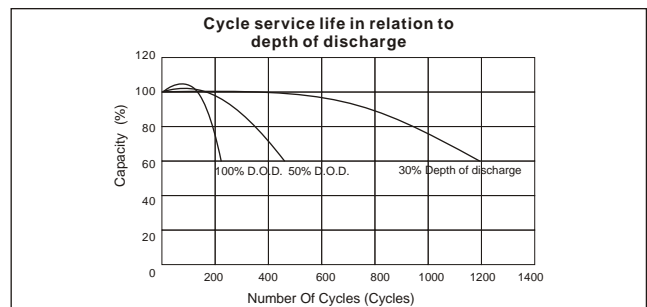
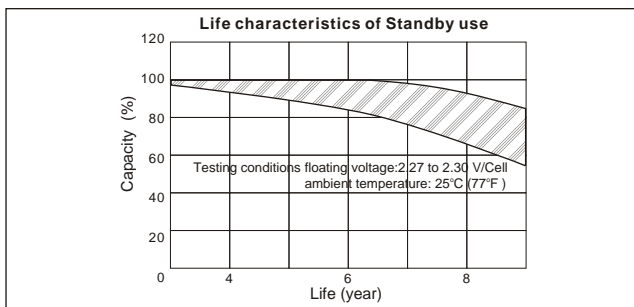
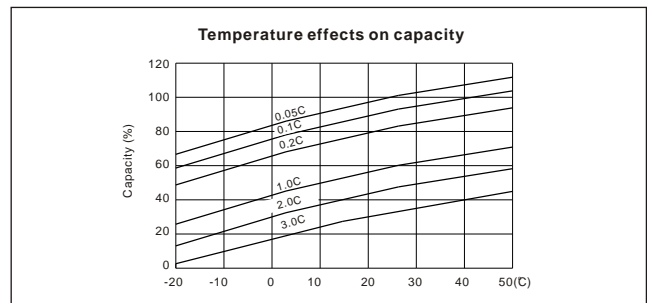
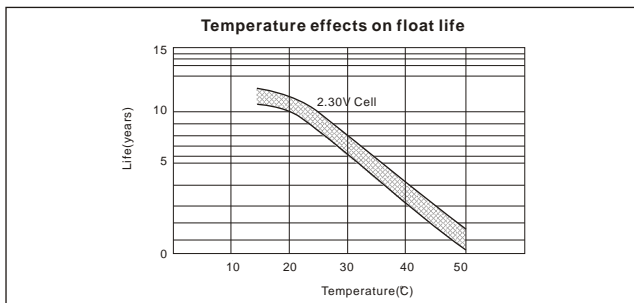
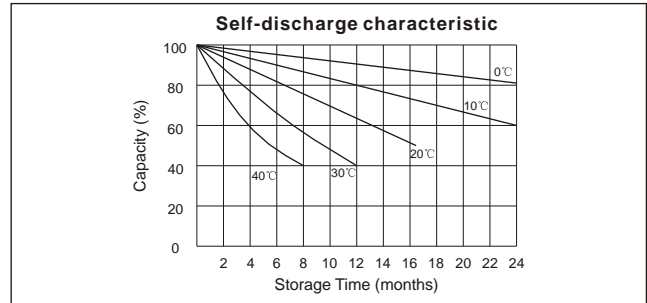
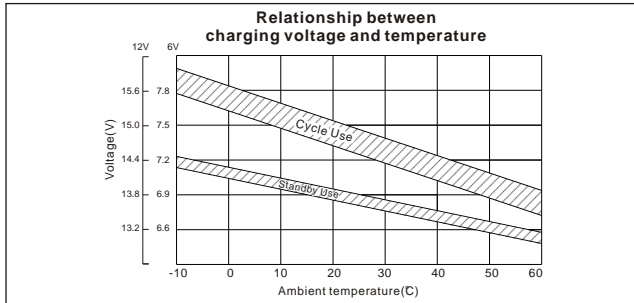
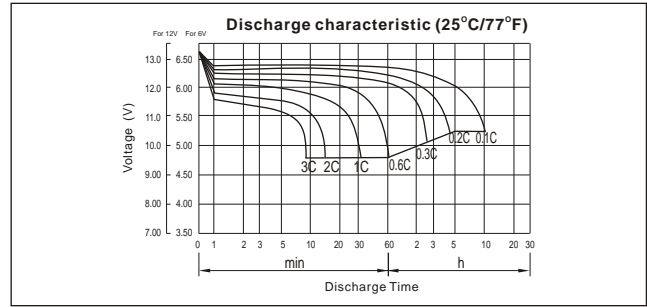
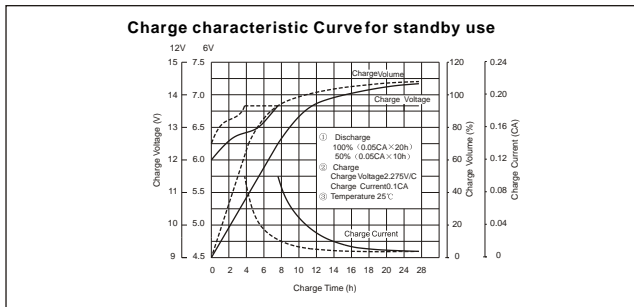

F.V/Time	Constant Current Discharge Characteristics(Amperes, 25°C)								Constant Power Discharge Characteristics(Watts, 25°C)							
	5min	10min	30min	1h	3h	5h	10h	20h	5min	10min	30min	1h	3h	5h	10h	20h
10.80V	50.2	47.7	22.0	12.50	5.33	3.50	2.00	1.00	634	420	178	108	57	37.7	21.20	12.17
10.50V	56.0	50.0	22.5	12.83	5.33	3.50	2.00	1.00	684	452	190	114	59	39.0	21.67	12.27
10.20V	64.0	50.7	23.2	13.17	5.50	3.67	2.00	1.00	736	483	203	120	60	40.7	21.87	12.33
9.60V	70.2	53.3	24.2	13.67	5.50	3.67	2.00	1.00	840	547	225	132	63	42.0	21.87	12.50

Packing Dimensions	327*194*202mm	Quantity Per Box	4pcs	Net weight Per Box	23.6kg	Gross weight Per Box	24.5 kg	
Splint	Europe (1200*800mm)	Australia(1150*1100mm)		Standard(1100*950mm)		Nonstandard (1000*1000mm)		
20'DRY 8.5'	2.64K		2.72K		2.68K		3.00K	



SHENZHEN CHIWAY BATTERY CO., LTD.

Jingyi Industrial Zone, NO.528 Jinbi Road, Pingshan Town, Longgang District, Shenzhen, China.
 Tel: (+86-755) 8993 0038 8993 1028 Fax: (+86-755)8993 0306 E-mail : sales@chiway-battery.com

www.chiway-battery.com