

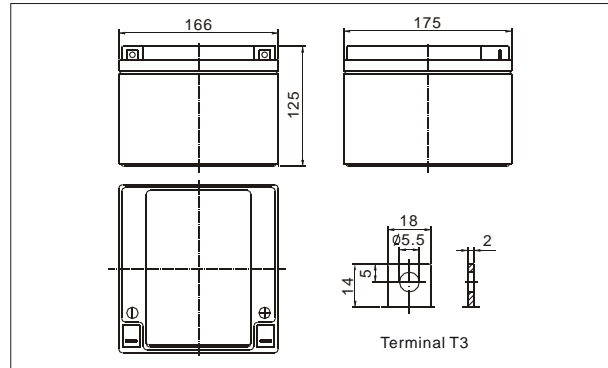

● **Outer dimensions (mm)**



The CHIWAY sealed lead-acid rechargeable battery (VRLA battery) is leak-proof and maintenance free. The Superiority of VRLA battery is derived from its uniquely efficient oxygen recombination technology. The oxygen evolved from the positive plates diffuses through the micro porous glass fiber mat to the negative plates where it is changed back to water by recombination reaction, eliminating the need for water addition. The result is a maintenance free battery.

● **Battery Construction**

Component	Positive plate	Negative plate	Container	Cover	Safety valve	Terminal	Separator	Electrolyte
Raw material	Lead dioxide	Lead	ABS	ABS	Rubber	Copper	Fiberglass	Sulfuric acid

● **General Features**

- Absorbent Glass Mat (AGM) technology for efficient gas recombination of up to 99% and freedom from electrolyte maintenance or water adding.
- Not restricted for air transport-complies with IATA/ICAO Special Provision A67.
- UL-recognized component.
- Can be mounted in any orientation.
- Computer designed lead, calcium tin alloy grid for high power density.
- Long service life, float or cyclic applications.
- Maintenance-free operation.
- Low self discharge.

● **Application**

- Electric powered vehicles
- Golf cars and buggies
- PDA equipment as laptop computer,
- Camera, phone sets, medical sets
- Power tools, Lawn mowers, vacuum cleaners
- Electric Powered Toys
- Wheel Chairs

● **Specifications**

Nominal Voltage		12V
Capacity (20 hr 25°C)		28Ah
Design Life		3-5 Years
Dimensions	Length	166 mm (6.54 inch)
	Width	175 mm (6.89 inch)
	Height	125 mm (4.92 inch)
	Total Height	125mm (4.92 inch)
Approx. Weight		9.00Kg (19.85 lbs)
Capacity 25°C (77°F)	20 hr rate	28Ah
	10 hr rate	26.04Ah
	3 hr rate	23.80Ah
	1 hr rate	16.8Ah
Internal Resistance (Full charged Battery at 25°C (77°F))		10 mΩ

Capacity affected by Temperature (20hr)	40°C	102%
	25°C	100%
	0°C	85%
	-15°C	65%
Self-Discharge at 25°C	3 month	Remaining capacity: 91%
	6 month	Remaining capacity: 82%
	12 month	Remaining capacity: 65%
Normal operating temperature		25°C ± 3°C (77°F ± 5°F)
Operating temperature range		-15°C ~ 50°C (5 ~ 122°F)
Float charging voltage (25°C)		13.6 to 13.8V
Cyclic charging voltage (25°C)		14.5 to 14.9V
Maximum charging current		11.20A
Terminal material		Copper
Maximum Discharge current		420A (5sec)

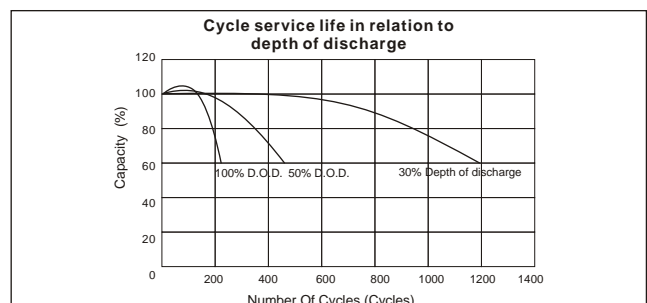
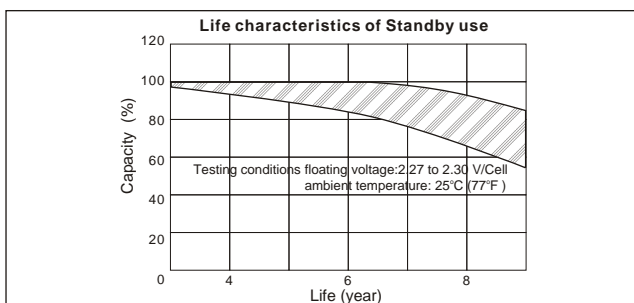
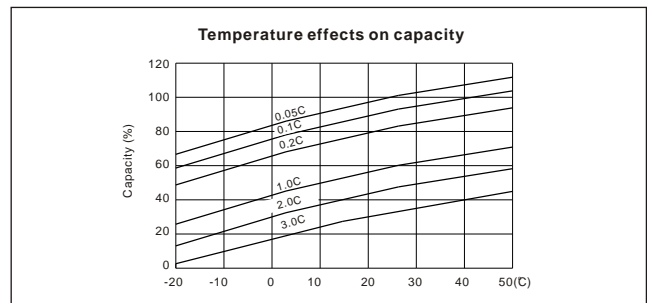
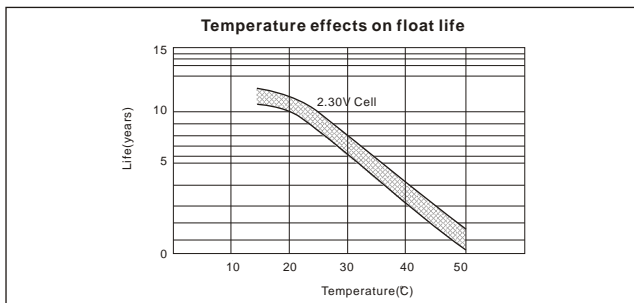
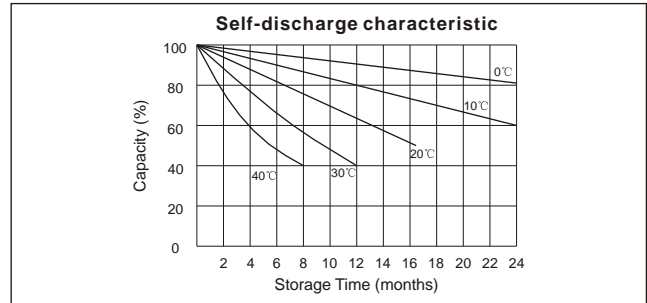
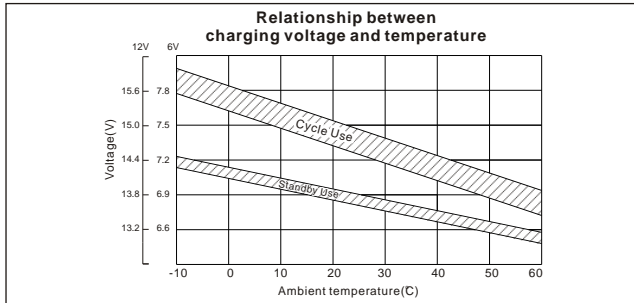
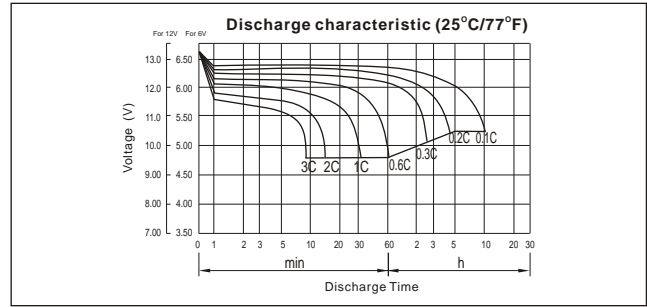
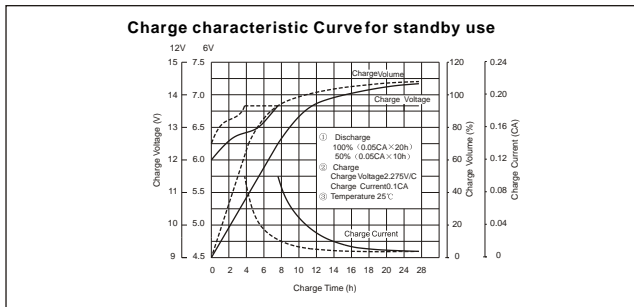

F.V/Time	Constant Current Discharge Characteristics(Amperes,25°C)								Constant Power Discharge Characteristics(Watts,25°C)							
	5min	10min	15min	30min	1h	3h	5h	10h	5min	10min	15min	30min	1h	3h	5h	10h
10.80V	70.2	66.7	30.8	17.50	7.47	4.90	2.80	1.40	888	588	250	151	80	52.7	29.68	17.03
10.50V	78.4	70.0	31.5	17.97	7.47	4.90	2.80	1.40	958	632	266	160	82	54.6	30.33	17.17
10.20V	89.6	70.9	32.4	18.43	7.70	5.13	2.80	1.40	1031	677	284	168	84	56.9	30.61	17.27
9.60V	98.2	74.7	33.8	19.13	7.70	5.13	2.80	1.40	1176	766	315	185	88	58.8	30.61	17.50

Packing Dimensions	359*200*151mm	Quantity Per Box	2 pcs	Net weight Per Box	18.0kg	Gross weight Per Box	18.8 kg
Splint	Europe (1200*800mm)	Australia(1150*1100mm)	Standard(1100*950mm)	Nonstandard (1100*800mm)			
20'DRY 8.5'	1.58k		1.80k	2.00k		2.00k	

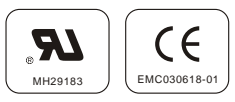

SHENZHEN CHIWAY BATTERY CO., LTD. www.chiway-battery.com
 Jingyi Industrial Zone, NO.528 Jinbi Road, Pingshan Town, Longgang District, Shenzhen, China.
 Tel: (+86-755) 8993 0038 8993 1028 Fax: (+86-755)8993 0306 E-mail : sales@chiway-battery.com