

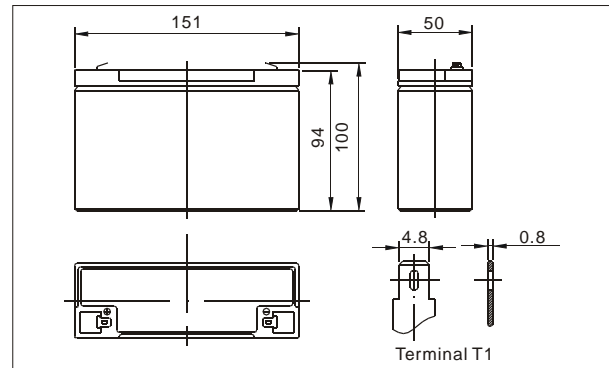

● Outer dimensions (mm)



The CHIWAY sealed lead-acid rechargeable battery (VRLA battery) is leak-proof and maintenance free. The Superiority of VRLA battery is derived from its uniquely efficient oxygen recombination technology. The oxygen evolved from the positive plates diffuses through the micro porous glassfiber mat to the negative plates where it is changed back to water by recombination reaction, eliminating the need for water addition. The result is a maintenance free battery.

● Battery Construction

Component	Positive plate	Negative plate	Container	Cover	Safety valve	Terminal	Separator	Electrolyte
Raw material	Lead dioxide	Lead	ABS	ABS	Rubber	Copper	Fiberglass	Sulfuric acid

● General Features

- Absorbent Glass Mat (AGM) technology for efficient gas recombination of up to 99% and freedom from electrolyte maintenance or water adding.
- Not restricted for air transport-complies with IATA/ICAO Special Provision A67.
- UL-recognized component.
- Can be mounted in any orientation.
- Computer designed lead, calcium tin alloy grid for high power density.
- Long service life, float or cyclic applications.
- Maintenance-free operation.
- Low self discharge.

● Application

- Electric powered vehicles
- Golf cars and buggies
- PDA equipment as laptop computer,
- Camera, phone sets, medical sets
- Power tools, Lawn mowers, vacuum cleaners
- Electric Powered Toys
- Wheel Chairs

● Specifications

Nominal Voltage		6V
Capacity (20 hr 25°C)		12Ah
Design Life		3-5 Years
Dimensions	Length	151 mm (5.94 inch)
	Width	50 mm (1.97 inch)
	Height	94mm (3.70 inch)
	Total Height	100mm (3.94 inch)
Approx. Weight		2.00Kg (4.41 lbs)
Capacity 25°C (77°F)	20 hr rate	12Ah
	10 hr rate	11.16Ah
	3 hr rate	10.20Ah
	1 hr rate	7.20Ah
Internal Resistance (Full charged Battery at 25°C (77°F))		11 m Ω

Capacity affected by Temperature (20hr)	40°C	102%
	25°C	100%
	0°C	85%
	-15°C	65%
Self-Discharge at 25°C	3 month	Remaining capacity: 91%
	6 month	Remaining capacity: 82%
	12 month	Remaining capacity: 65%
Normal operating temperature		25°C ±3°C (77°F ±5°F)
Operating temperature range		-15°C ~50°C (5~122°F)
Float charging voltage (25°C)		6.80 to 6.90V
Cyclic charging voltage (25°C)		7.25 to 7.45V
Maximum charging current		4.80A
Terminal material		Copper
Maximum Discharge current		180A (5sec)

Charge characteristic Curve for standby use



Discharge characteristic (25°C/77°F)



Relationship between charging voltage and temperature

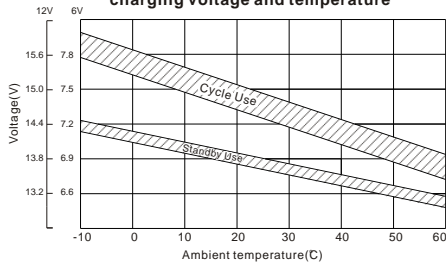

Self-discharge characteristic



Temperature effects on float life



Temperature effects on capacity



Life characteristics of Standby use

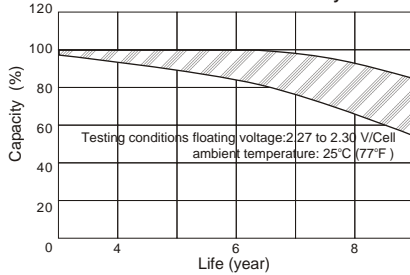

Cycle service life in relation to depth of discharge

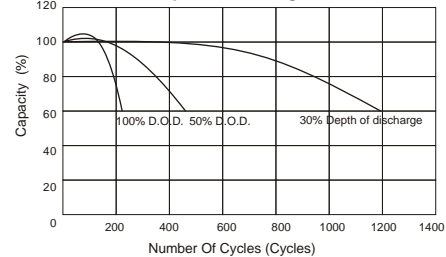

F.V/Time	Constant Current Discharge Characteristics(Amperes, 25°C)								Constant Power Discharge Characteristics(Watts, 25°C)							
	5min	10min	15min	30min	1h	3h	5h	10h	5min	10min	15min	30min	1h	3h	5h	10h
5.40V	30.1	28.6	13.2	7.5	3.2	2.1	1.2	0.6	190.3	126.0	53.5	32.4	17.1	11.3	6.4	3.7
5.25V	33.6	30.0	13.5	7.7	3.2	2.1	1.2	0.6	205.2	135.5	57.1	34.2	17.6	11.7	6.5	3.7
5.10V	38.4	30.4	13.9	7.9	3.3	2.2	1.2	0.6	220.9	145.0	60.8	36.0	18.0	12.2	6.6	3.7
4.80V	42.1	32.0	14.5	8.2	3.3	2.2	1.2	0.6	252.0	164.2	67.5	39.6	18.9	12.6	6.6	3.8

Packing Dimensions	329*386*124mm	Quantity Per Box	10pcs	Net weight Per Box	20.0kg	Gross weight Per Box	20.8 kg
Splint	Europe (1200*800mm)	Australia(1150*1100mm)	Standard(1100*950mm)	Nonstandard (1000*900mm)			
20'DRY 8.5'	8.36k	8.36k	8.28k	8.28k			



SHENZHEN CHIWAY BATTERY CO., LTD.

Jingyi Industrial Zone, NO.528 Jinbi Road, Pingshan Town, Longgang District, Shenzhen, China.
Tel: (+86-755) 8993 0038 8993 1028 Fax: (+86-755)8993 0306 E-mail : sales@chiway-battery.com

www.chiway-battery.com