

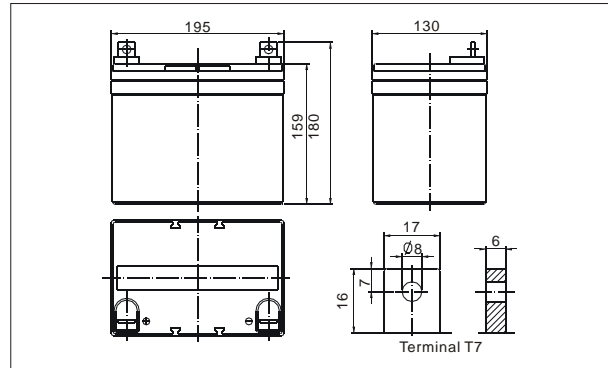

● Outer dimensions (mm)



The CHIWAY sealed lead-acid rechargeable battery (VRLA battery) is leak-proof and maintenance free. The Superiority of VRLA battery is derived from its uniquely efficient oxygen recombination technology. The oxygen evolved from the positive plates diffuses through the micro porous glass fiber mat to the negative plates where it is changed back to water by recombination reaction, eliminating the need for water addition. The result is a maintenance free battery.

● Battery Construction

Component	Positive plate	Negative plate	Container	Cover	Safety valve	Terminal	Separator	Electrolyte
Raw material	Lead dioxide	Lead	ABS	ABS	Rubber	Pb	Fiberglass	Sulfuric acid

● General Features

- Absorbent Glass Mat (AGM) technology for efficient gas recombination of up to 99% and freedom from electrolyte maintenance or water adding.
- Not restricted for air transport-complies with IATA/ICAO Special Provision A67.
- UL-recognized component.
- Can be mounted in any orientation.
- Computer designed lead, calcium tin alloy grid for high power density.
- Long service life, float or cyclic applications.
- Maintenance-free operation.
- Low self discharge.

● Application

- Electric powered vehicles
- Golf cars and buggies
- PDA equipment as laptop computer,
- Camera, phone sets, medical sets
- Power tools, Lawn mowers, vacuum cleaners
- Electric Powered Toys
- Wheel Chairs

● Specifications

Nominal Voltage		12V
Capacity (10 hr 25°C)		36Ah
Design Life		10 Years
Dimensions	Length	195 mm (7.68 inch)
	Width	130 mm (5.12 inch)
	Height	159 mm (6.26 inch)
	Total Height	180 mm (7.09 inch)
Approx. Weight		11.0 Kg (24.23 lbs)
Capacity 25°C (77°F)	10 hr rate	36Ah
	3 hr rate	28.8Ah
	1 hr rate	23.4Ah
Internal Resistance (Full charged Battery at 25°C (77°F))		9.5 mΩ

Capacity affected by Temperature (20hr)	40°C	102%
	25°C	100%
	0°C	85%
	-15°C	65%
Self-Discharge at 25°C	3 month	Remaining capacity: 91%
	6 month	Remaining capacity: 82%
	12 month	Remaining capacity: 65%
Normal operating temperature		25°C ± 3°C (77°F ± 5°F)
Operating temperature range		-15°C ~ 50°C (5 ~ 122°F)
Float charging voltage (25°C)		13.6 to 13.8V
Cyclic charging voltage (25°C)		14.5 to 14.9V
Maximum charging current		10.8A
Terminal material		Pb
Maximum Discharge current		360A (5sec)

**Charge characteristic Curve for standby use**

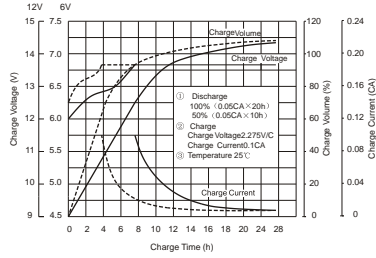

**Discharge characteristic (25°C/77°F)**

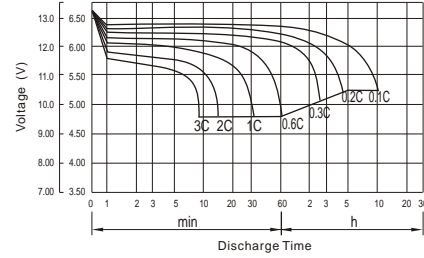

**Relationship between charging voltage and temperature**



**Self-discharge characteristic**

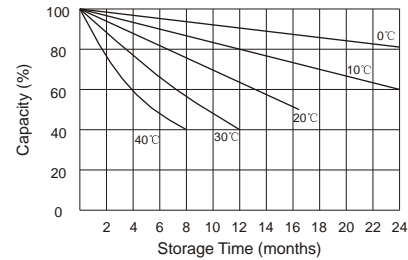

**Temperature effects on float life**

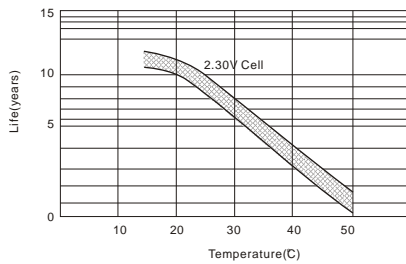

**Temperature effects on capacity**



**Life characteristics of Standby use**

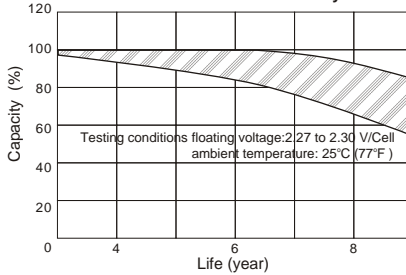

**Cycle service life in relation to depth of discharge**

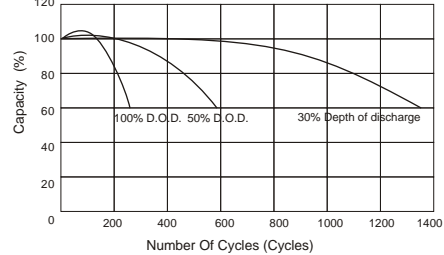

**Constant Current Discharge Characteristics(Amperes, 25°C)**

**Constant Power Discharge Characteristics(Watts, 25°C)**

F.V/Time	Constant Current Discharge Characteristics(Amperes, 25°C)								Constant Power Discharge Characteristics(Watts, 25°C)							
	5min	10min	15min	30min	1h	3h	5h	10h	5min	10min	15min	30min	1h	3h	5h	10h
10.80V	95.8	68.7	51.8	31.7	22.3	9.00	6.05	3.60	1054.8	741.8	568.8	360.0	255.6	104.4	70.2	43.0
10.50V	100.8	71.5	59.4	35.3	22.7	9.36	6.28	3.64	1108.8	765.8	565.8	403.2	260.6	109.8	73.8	43.2
10.20V	108.0	73.6	63.3	38.9	23.0	9.54	6.41	3.67	1170.0	789.8	694.8	442.8	265.0	111.6	74.9	43.4
9.60V	126.0	76.9	70.2	43.2	23.4	9.72	6.41	3.71	1368.0	831.3	774.0	496.8	268.6	113.4	75.6	43.6

Packing Dimensions	219*154*210mm	Quantity Per Box	1 pcs	Net weight Per Box	11.0kg	Gross weight Per Box	11.5 kg
Splint	Europe (1200*800mm)	Australia(1150*1100mm)	Standard(1100*950mm)	Nonstandard (1100*950mm)			
20'DRY 8.5'	1144PCS	1480PCS	1440PCS	1440PCS			



**SHENZHEN CHIWAY BATTERY CO., LTD.**

Jingyi Industrial Zone, NO.528 Jinbi Road, Pingshan Town, Longgang District, Shenzhen, China.  
Tel: (+86-755) 8993 0038 8993 1028 Fax: (+86-755)8993 0306 E-mail : sales@chiway-battery.com

[www.chiway-battery.com](http://www.chiway-battery.com)