

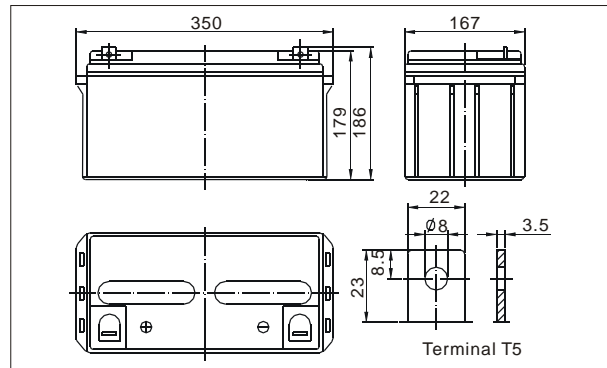

● **Outer dimensions (mm)**



The CHIWAY sealed lead-acid rechargeable battery (VRLA battery) is leak-proof and maintenance free. The Superiority of VRLA battery is derived from its uniquely efficient oxygen recombination technology. The oxygen evolved from the positive plates diffuses through the micro porous glass fiber mat to the negative plates where it is changed back to water by recombination reaction, eliminating the need for water addition. The result is a maintenance free battery.

● **Battery Construction**

Component	Positive plate	Negative plate	Container	Cover	Safety valve	Terminal	Separator	Electrolyte
Raw material	Lead dioxide	Lead	ABS	ABS	Rubber	Copper	Fiberglass	Sulfuric acid

● **General Features**

- Absorbent Glass Mat (AGM) technology for efficient gas recombination of up to 99% and freedom from electrolyte maintenance or water adding.
- Not restricted for air transport-complies with IATA/ICAO Special Provision A67.
- UL-recognized component.
- Can be mounted in any orientation.
- Computer designed lead, calcium tin alloy grid for high power density.
- Long service life, float or cyclic applications.
- Maintenance-free operation.
- Low self discharge.

● **Application**

- Electric powered vehicles
- Golf cars and buggies
- PDA equipment as laptop computer,
- Camera, phone sets, medical sets
- Power tools, Lawn mowers, vacuum cleaners
- Electric Powered Toys
- Wheel Chairs

● **Specifications**

Nominal Voltage		12V
Capacity (10 hr 25°C)		65Ah
Design Life		10 Years
Dimensions	Length	350 mm (13.78 inch)
	Width	167 mm (6.57 inch)
	Height	179 mm (7.05 inch)
	Total Height	186 mm (7.32 inch)
Approx. Weight		26 Kg (57.33 lbs)
Capacity 25°C (77°F)	10 hr rate	80Ah
	3 hr rate	64Ah
	1 hr rate	52Ah
Internal Resistance (Full charged Battery at 25°C (77°F))		5.5 mΩ

Capacity affected by Temperature (20hr)	40°C	102%
	25°C	100%
	0°C	85%
	-15°C	65%
Self-Discharge at 25°C	3 month	Remaining capacity: 91%
	6 month	Remaining capacity: 82%
	12 month	Remaining capacity: 65%
Normal operating temperature		25°C ± 3°C (77°F ± 5°F)
Operating temperature range		-15°C ~ 50°C (5 ~ 122°F)
Float charging voltage (25°C)		13.6 to 13.8V
Cyclic charging voltage (25°C)		14.5 to 14.9V
Maximum charging current		24A
Terminal material		Copper
Maximum Discharge current		800A (5sec)

Charge characteristic Curve for standby use



Discharge characteristic (25°C/77°F)

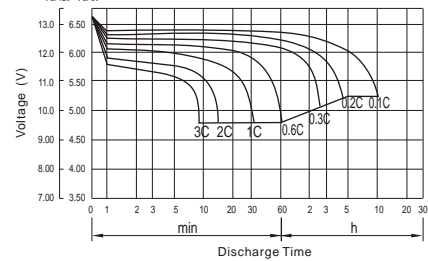

Relationship between charging voltage and temperature

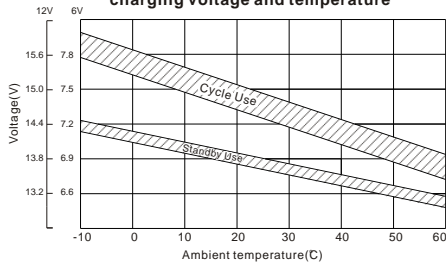

Self-discharge characteristic

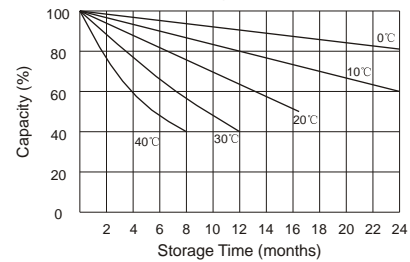

Temperature effects on float life

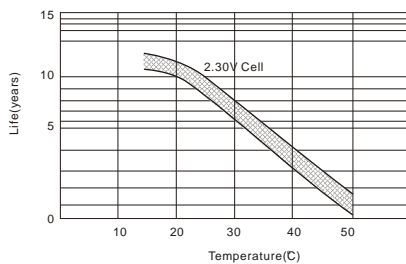

Temperature effects on capacity



Life characteristics of Standby use

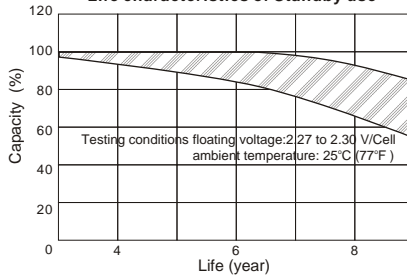

Cycle service life in relation to depth of discharge

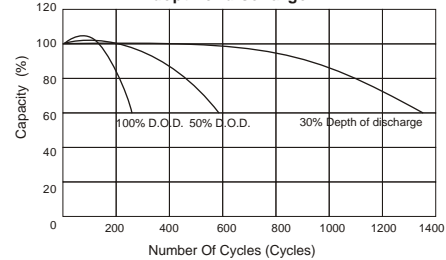

F.V/Time	Constant Current Discharge Characteristics(Amperes, 25°C)								Constant Power Discharge Characteristics(Watts, 25°C)							
	5min	10min	15min	30min	1h	3h	5h	10h	5min	10min	15min	30min	1h	3h	5h	10h
10.80V	212.8	152.7	115.2	70.4	49.6	20.00	13.44	8.00	2344.0	1648.5	1264.0	800.0	568.0	232.0	156.0	95.5
10.50V	224.0	158.8	132.0	78.4	50.4	20.80	13.95	8.08	2464.0	1701.8	1701.8	896.0	579.2	244.0	164.0	96.0
10.20V	240.0	163.6	140.7	86.4	51.2	21.20	14.24	8.16	2600.0	1755.2	1544.0	984.0	588.8	248.0	166.4	96.5
9.60V	280.0	170.9	156.0	96.0	52.0	21.60	14.24	8.24	3040.0	1847.3	1720.0	1104.0	596.8	252.0	168.0	97.0

Packing Dimensions	374*191*210mm	Quantity Per Box	1 pcs	Net weight Per Box	24.0kg	Gross weight Per Box	24.5 kg
Splint	Europe (1200*800mm)	Australia(1150*1100mm)	Standard(1100*950mm)	Nonstandard (1150*800mm)			
20'DRY 8.5'	528PCS	600PCS	576PCS	660PCS			



### SHENZHEN CHIWAY BATTERY CO., LTD.

Jingyi Industrial Zone, NO.528 Jinbi Road, Pingshan Town, Longgang District, Shenzhen, China.  
Tel: (+86-755) 8993 0038 8993 1028 Fax: (+86-755)8993 0306 E-mail : sales@chiway-battery.com

www.chiway-battery.com